

Epidermis, which was probably a Prolongation of the Nervous Papillæ grown to about the Size of common Twine Packbread; and these standing as close together as the Bristles in a Brush, seemed, like them, to be all shorn off even, and of the same Length, viz. about half an Inch above the Skin.

Fig. 3. Shews some of these Bristles, or Stumps, magnified; where it is visible that some of them are flat at Top, others concave; some pointed like a Cone, and others very irregular.

II. Conjectures upon the Nature of Intermitting and Reciprocating Springs. By Mr. Joseph Atwell, F. R. S.

BEFORE I offer the following Thoughts to the Consideration of the Society, I beg leave to premise something upon the Nature of Philosophical Conjectures in general, and the Sense in which I would be understood to propose these in particular.

A just and satisfactory Account of any one Phænomenon in Nature, cannot be expected without a true and perfect History of the Fact. This is seldom to be met with: Those who live nearest the Place of any natural Curiosity, and have the best Opportunity of making proper Observations upon it, seldom regard what Time and Use have rendered familiar. On the other hand, Strangers and Travellers, inclined to make a better Enquiry into Things of this Kind, are too often, if not always, in want of Time,

as well as other Conveniencies, for acquiring a due Knowledge of the Thing ; and therefore they content themselves with some slight Observations of their own, supplying the rest from the common, but generally fabulous, Reports of the Neighbourhood. Add to this, that a strong Propensity in Mankind towards the Marvellous, with the Surprise usually attending uncommon Sights, often hinders Men from seeing Things in a true Light ; and even sometimes imposes upon them so far, as to make them report things under Circumstances absolutely false.

Every curious Person can, I believe, furnish himself with Instances of these Truths, from his own Observations compared with the Accounts of others : But notwithstanding so weak a Foundation for raising Philosophical Conjectures, they will still have their use, if they are not imposed upon the World for Accounts of things certain, to be entirely acquiesced in. Let them be modestly offered as meer Hypotheses submitted to a farther Examination, and then their Consequences will be so many Particulars, which, being carefully examined and compared with the Phænomena themselves, may serve to refute, correct, or confirm the said Hypotheses, from whence they were deduced.

It is in this Sense only, and with such a View, that I offer the following Conjectures upon the Subject of intermitting and reciprocating Springs. For though these Thoughts were suggested to me by the Phænomena of a particular Fountain, seen by my self this last Winter, yet I am sensible that my Observations made on it are very imperfect, in Comparison of what the *Society* may expect and I my self hope hereafter
to

to give them : And as the Conjectures were framed chiefly for my own use, against another Opportunity of observing this Fountain more carefully ; so they are now communicated only for the use of others, who may perchance find such an Opportunity before me. These Observations will however discover something of the Nature of this Spring not yet imparted to the *Society*, nor taken notice of by the Naturalists, so far as I know, in any other Spring whatsoever. But since they are few, and imperfect, I shall be more particular in my Relation of them, that no greater Strefs may be laid on them than they deserve.

The Spring is situated at one End of the Town of *Brixam* near *Torbay* in *Devonshire*, and is known by the Name of *Laywell*. It is a long Mile distant from the Sea, upon the North and North-East Side of a Ridge of Hills lying between it and the Sea, and making a Turn or Angle near this Spring. It is situated in the Side of those Hills, near the Bottom, and seems to have its Course from the South-West towards the North-East. There is a constantly running Stream which discharges itself near one Corner into a Basin about eight Foot in Length, and four Foot and a half in Breadth ; the Outlet of which is at the farthest End from the Entrance of the Stream, about three Foot wide, and of a sufficient Height. This I mention, that a better Judgment may be made of the perpendicular Rise of the Water in the Basin, at the time of the Flux or Increase of the Stream. Upon the outside of the Basin are three other Springs, which always run, but with Streams subject to a like regular Increase and Decrease with the former. They seem

feem indeed only Branches of the former, or rather Channels difcharging fome Parts of the constantly running Water, which could not empty itfelf all into the Bafon; and therefore when by means of the Seafon, or Weather, Springs are large and high, upon the Flux or Increase of this Fountain feveral other little Springs are faid to break forth, both in the Bottom of the Bafon, and without it, which difappear again upon the Ebb or Decreafe of the Fountain. All the constantly running Streams put together, at the time that I faw them, were, I believe, more than fufficient to drive an Over-fhut Mill; and the Stream running into the Bafon, might be about one half of the whole.

I had made a Journey purpofely to fee it, in Company with a Friend. When we came to the Fountain, we were informed by a Man, working juft by the Bafon, that the Spring had flow'd and ebb'd about twenty times that Morning; but had ceas'd doing fo, about half an Hour before we came. I obferved the Stream running into the Bafon, for more than an Hour by my Watch, without perceiving the leaft Variation in it; or the leaft Alteration in the Height of the Surface of the Water in the Bafon; which we could obferve with great Nicety, by means of a broad Stone laid in a fhelving Position in the Water. Thus difappointed, we were obliged to go and take fome little Refreshment at our Inn; after which we intended to come back and fpend the reft of our Time by the Fountain, before we returned Home. They told us in the Town, that many had been difappointed in this manner; and the common People fuperftitiously imputed it to I know not what Influence which the Prefence of fome People had over the Fountain;

for

for which reason they advised, that in case it did not flow and ebb when we were both present, one of us should absent himself, to try whether it would do so in the Presence of the other.

Upon our Return to it, the Man, who was still at work, told us, that it began to flow and ebb about half an Hour after we went away, and had done so ten or twelve times. In less than a Minute, we saw the Stream coming into the Basin, and likewise the others on the outside of the Basin, begin to increase and to flow with great Violence; upon which the Surface of the Water in the Basin rose an Inch and a quarter perpendicularly, in near the Space of two Minutes: Immediately after which, the Stream began to abate again to its ordinary Course; and in near two Minutes time the Surface was sunk down to its usual Height, where it remained near two Minutes more. Then it began to flow again as before; and in the Space of twenty-six Minutes flow'd and ebb'd five times: So that an Increase, Decrease and Pause, taken together, were made in about five Minutes, or a little more.

I could observe by the Mark upon the Stones, that the Surface of the Water in the Basin had rose before we came at least three Quarters of an Inch perpendicularly higher than when we saw it; and I thought that I could perceive some very little Abatement each Turn, both in the Height, and in the Time of the rising of the Surface, and consequently in the Time of its sinking; but the Time of the Pause, or standing of the Surface at its usual Height, or equable running of the Stream, was lengthened; yet so, as to leave some Abatement in the time of the rising,
sinking,

sinking, and Pause taken together. This is all which my short Time would allow me to observe ; many more things should have been taken notice of, as will appear from the Hypothesis proposed to explain these Phænomena.

But before I enter upon explaining that Hypothesis, I must remark what Difference or Agreement is to be found between this Account of the Fountain, and another published in the *Philos. Transf.* Numb. 204, p. 909, 910, in two Letters from Dr *Oliver to Walter Moyle, Esq;* The Doctor places it a Mile and half from *Brixam*: I suppose he means *Brixam-Quay*, which is more than a Mile off from the Town. He gives the Dimensions of the Basin a little different from mine, making the Surface of it thirty Foot square, whereas I make it thirty-six Foot. He says, that it ebbs and flows very often every Hour ; which is certainly false, as appears both by common Report, and by my own Observation. When it once begins indeed to flow and ebb, it continues to do so several times in an Hour ; but then there is after this again a certain Space of Time, perhaps two Hours or more, when it runs with an equable Stream, without any the least Variation: And this is a particular Circumstance not observed in any Spring whatsoever that I have heard of. When the Doctor first saw it, *viz.* in *July 1693*, he says that he judged the Flux and Reflux, as he calls them, to be performed in about two Minutes: If he means two Minutes each, it agrees very well with my own Observations ; but as he had neither Glass nor Minute-Watch with him, this Observation cannot be depended on. When he saw it again, *viz.* in *August* the same Year, he judged it to flow slower than
before ;

before; which he explains by saying, that though it performed its Flux and Reflux in little more than a Minute (which by the way is quicker than before) yet it would stand at the Low-Water Mark two or three Minutes; which I suppose he calls flowing slower than before, because the Space of Time between the End of the Ebb, and the Beginning of the succeeding Flux was longer. I had never read this Account 'till lately; long since my own Observations were made; but, if we suppose the Doctor to have made his Observations somewhat nearer the Time when the Fountain was to cease ebbing and flowing, than I made mine, our Observations will perhaps exactly agree: The Time of the Flux and Reflux being shorter, the Time of the Pause longer, but the whole Time of the Flux, Reflux, and Pause taken together being shorter by his Account than by my own. He says, that he found it by his Watch to flow and ebb sixteen times in an Hour: I do not suppose that he made a whole Hour's Observations, which must have shewn him a Difference in the Times of the Reciprocations that he did not perceive; but having observed, that one Reciprocation, or a Flux, Reflux, and Pause, took up about the Space of four Minutes, he from thence computed, as I imagine, that there would be sixteen in an Hour, presuming that there was no Alteration in the Times. In this Sense I would understand him, when he adds, that he was informed it sometimes flowed twenty Times in an Hour. For, according to his Observations, it flowed at the rate of sixteen Times in a Hour; according to my own Observations, at the rate of twelve Times in an Hour; perhaps before my Observations at a less Rate, and after his at a greater: So that in the whole Hour, according to the several Rates taken together, it may flow

and ebb about nine or ten Times, according to another Account which I have received ; but of this I can assert nothing certain, or upon my own Observations. The Doctor adds, that when the Water in the Bason began to rise, he observed a Bubbling in the Bottom of the Bason, which ceased when the Water began to sink. This I did not see, because the Springs were small and low, by means of a dry Season ; but it was confirmed to me by the Report of Eye-witnesses, as is before observed.

Having thus compared the two Accounts given of this Fountain, I come now to my Hypothesis, for explaining the Phænomena observed by me ; and I imagine them to be occasioned by two Streams or Springs, one of which passing through two Caverns or natural Reservoirs with Syphons, meets with the other Stream in a third Reservoir without a Syphon ; where being joined, they come out of the Earth together. This complicated Piece of Machinery will be best understood by beginning with an Explanation of the more simple Parts first ; in doing of which, we shall have an Opportunity of considering some other Sorts of Fountains, which have already been observed, or may hereafter be found to be in Nature.

The *Petitio Principii*, or Supposition of Reservoirs and Syphons in the Bowels of the Earth, has been made by others : *Père Regnault*, in his *Phil. Conversations*, Vol. 2. Conv. 6. p. 125, &c. *Eng. Edit.* has mentioned it in general, and Dr. *Desaguliers*, in *Phil. Transf.* Numb. 384, has attempted to apply it to two Cases in particular ; as *Dechalets*, Tract. xvii. de *Fontibus Naturalibus*, &c. Prop. xv. had done in two other Cases before him. Nor is it unnatural or hard to be granted. Whosoever has seen the *Peak of Derby-*

Derbyshire, the Hilly Parts of *Wales*, or other Countries, must be satisfied that they abound with Caverns of many sorts. Some of them are dry, others serve only for Passages, or Channels to Streams, which run through them; and a third Sort collect and hold Water, 'till they are full. They must likewise have observed, that there are sometimes narrow Passages running between the Rocks which compose the Sides, and going from one Cavern to another. Such a Passage, of whatsoever Shape or Dimensions, how crooked and winding soever in its Course, if it be but tight, and runs from the lower Part of the Cavern, first upwards to a less Height than that of the Cavern, and then downwards below the Mouth of the said Passage, will be a natural Syphon.

A natural Reservoir then, Tab. II. *Fig.* 1. ABCD, with such a natural Syphon, MNP may be supposed. Let a Stream, which I shall call the Feeding-Stream, enter it, near the Top at O. The said Cavern must contain all the Water which comes in at O, 'till it is filled to the Top of the Syphon at N. Then the Syphon beginning to play, and being supposed always to discharge more Water than comes in by the Feeding-Stream at O, will empty the Cavern, 'till the Water is sunk in it below the Mouth of the Syphon at M; when it must stop, 'till the Cavern is filled, and the Syphon runs again as before. If the Water discharged by such a Syphon, MP be brought out of the Earth by a Channel PQ, the Water will flow out of the Earth, and stop alternately, making an intermitting Fountain at Q.

By this plain and easy Contrivance, several of the flowing and ebbing Springs observed by the Naturalists, may probably be explained; and even a much greater Variety of them than is hither-

to known. For if the Feeding-Stream at O should arise only from the Rains in Winter, or from the melting of the Snow in Summer, the intermitting Fountain would become a temporary Spring, as Dr. Plot calls such Springs which are confined to a Season. Or if the Feeding-Stream at O should be constant, but yet liable with other Springs to an Increase and Decrease arising from the Seasons, Weather, or other Causes, the Construction of the Syphon would make a great Alteration. For when the Syphon is so made, that its Discharge (which is continually decreasing, as the Surface of the Water subsides in the Cavern) shall at any Time be equal to the Feeding-Stream entering at O, in such a Case, the Syphon must continually run, and yet not empty the Cavern, 'till the Feeding-Stream at O is sufficiently diminished. But, when the Diameter of the Syphon at N, according to the Height of the Cavern, is so great, and the Feeding-Stream at O so small, that the Syphon can carry off (in the Manner of a Waste-Pipe) all the Water which comes in, and yet not run with a full Stream; the Syphon must then continue, to run without emptying the Cavern, 'till the Feeding-Stream at O is sufficiently enlarged. So that by these different Constructions of the Syphon, there may be some Fountains which shall flow constantly in the Winter, or a wet Season, and intermit in the Summer, or a dry Season; and on the contrary, others which shall flow continually in the Summer, or a dry Season, and intermit in the Winter, or a wet Season. There is a third Variety, which may arise from the Make of the Syphon, and will occasion such Irregularities as admit of no certain Explanation. This happens when the Discharge of the Syphon at the very last is just equal to the Feeding-Stream, and the Cavity of the Syphon at N

is

is large ; for in this Cafe, the Air-Bubbles, made by the Fall of the Feeding-Stream from O to the Bottom of the Cavern, will fometimes accidentally get into the Mouth of the Syphon at M, and lodging at N, will fo choak it as to render its running and ftopping, as well as the Quantity of its Difcharge, entirely uncertain ; fo that thefe fort of Fountains will admit of no farther Confideration.

But before I leave the Confideration of Fountains explicable by one Refervoir and Syphon, it may not be amifs to obferve, that thofe which intermit regularly will have their Flux always longer, and their Paufe or Intermiffion fhorter in Winter and in wet Weather, than in Summer or in a dry Seafon ; which is a Confequence of this Hypothefis, by which it may be examined, whether it be applicable to any particular intermitting Fountain, or not.

If the fingle Refervoir and Syphon has another Out-let at R, *Fig. 2.* fituated between the Bottom C D of the Cavern, and the Top of the Syphon N, we fhall have another kind of Fountains. For if the Feeding-Stream at O, is capable of being difcharged by the Out-let at R, a Fountain derived from R will continually run, whilft the Feeding-Stream can be difcharged that Way, and will encrease and decrease with any little Alteration happening to the Feeding-Stream at O, provided that the faid Stream does not grow too large for the Out-let at R. But in that Cafe the Cavern muft be filled up to N, and the Syphon may begin to play ; which, together with the Out-let at R, may difcharge fo much as to make the Surface of the Water in the Cavern fink below R, and confequently the Fountain proceeding from R muft ftop. If the Difcharge of the Syphon is fo great as to empty the Cavern, then the Fountain
derived

derived from R will, after some time, begin to run again, and encrease 'till the Water rises in the Cavern to N; after which it will decrease, and at length stop. But if the Discharge of the Syphon only keeps the Surface of the Water below R, without emptying the Cavern, then the Fountain derived from R shall be dried up, so long as the Stream at O continues encreased; and shall run again when the said Feeding-Stream is lessened. Thus we may have a Spring which shall run all Summer, and be dry all Winter: Such a Spring will encrease just before it begins to fail, *i. e.* whilst the Water in the Cavern is rising to N, will be dried up sooner in a wet Summer, and break out later in a wet Winter, contrary to the Nature of other Springs. Which Particulars are worthy of Observation in such sort of Springs (of which it is said we have some in *England*) and will serve to discover, whether they are occasioned by this kind of Machinery, or not.

If the Syphon *Fig. 3.* MNP, of the Reservoir ABCD, having no Out-let at R, should discharge itself into a second Reservoir EFGH of a smaller Capacity, but furnished with a Syphon STV, which discharges the Water more plentifully than it comes in; a Fountain derived from this second Syphon STV would flow and intermit, whilst the first Syphon MNP continued running; *i. e.* 'till the great Reservoir ABCD should be emptied. After which it would entirely stop, 'till the said Reservoir ABCD was filled again by the Feeding-Stream at O, and then it would flow and intermit as before.

Such a Sort of compound Fountain would be liable to all the Variations of the former Fountains derived from a single Reservoir, if we take the Fits of flowing

ing and intermitting of this for the Flux of the former, and the long Stop in this, whilst the great Reservoir is filling, for the Pause or Intermiffion of the former. Besides which, we must remark, that as the Flux in the former Fountains may be changed, and be made longer or shorter ; so in this, the Number of Intermiffions during one Fit of flowing and intermitting may not always be the same, because of the different Capacities of the two Reservoirs, and a Difference or Change occasioned in the Feeding-Stream at O. For if, whilst the great Reservoir A B C D is emptying, the little Reservoir E F G H should empty itself nine times, for Instance, and be half full again, the Fountain derived from its Syphon S T V must have nine Intermiffions in one Fit, and ten in another, alternately, whilst the Feeding-Stream at O remains the same. But the Feeding-Stream at O being lessened or enlarged, without making the Syphon M N P run continually, the Number of Intermiffions in each Fit will be diminished or augmented accordingly. But 'tis peculiar to this last Sort of Fountains, that in each Fit of flowing and intermitting, the first Flux will be larger and longer than the second, and the second than the third ; but the first Intermiffion will be shorter than the second, and the second than the third : because the Syphon M N P running faster at first than at last, the Reservoir E F G H must be a shorter Time in being filled, and a longer Time in being emptied the first Time than the second ; the second than the third, and so on. As to the whole Time of the first Flux and Intermiffion, in Comparison of the whole Time of the second Flux and Intermiffion, it is a Particular, requiring so many Things to be taken into Consideration, for determining it in
each

each Cafe, that I shall wave it here, and content myself with fhewing that it may be longer, by an Experiment that will prefently be made. Another Variety in this Sort of Fountains might be made by a fecond Feeding-Stream Z, coming into the fecond Refervoir E F G H; but the bare mentioning of that will at prefent be fufficient.

If in the Contrivance of a fingle Refervoir and Syphon, the Stream derived from the Syphon fhould fall into another Refervoir *Fig. 4.* I K K L, having no Syphon, but only a common Out-let X, and fhould in this Refervoir meet and join with another Stream constantly running, a Fountain derived from the faid Out-let X would be a Reciprocating-Spring; by which Name I call thofe Springs which flow constantly, but with a Stream fubject to encrease and decrease, to diftinguifh them from Intermitting-Springs, which flow and flop alternately. And if the Out-let X be too fmall to carry off all the Water brought into the Refervoir I K K L, by the Syphon, over and above what is brought in by the constantly running Stream W; then the Surface of the Water in the faid Refervoir I K K L muft continually rife, 'till the Velocity of the Stream going out at X, is fufficiently encreafed, to carry off the Water coming in: Upon which, the Difcharge of the Syphon being continually leffened, the faid Surface will again fubfide, and the Velocity of the Stream at X will diminifh; fo that both the Encrease and Decrease in this Reciprocating-Fountain will be gradual. Befides, if the Refervoir I K K L, or the Channel derived from it, fhould have any Leaks, Crevices, or other Out-lets, the Water will iffue through them upon the Riling of the Surface in the faid Refervoir, and occafion Springs, which will ceafe again when the Surface fubfides.

Let

Let us now suppose such a Reservoir *Fig. 5.* IKKL, with a constantly running Stream W, and an Out-let X, to receive the Water of a Syphon STV, coming through two Reservoirs ABCD and EFGH, as before described. A Fountain derived from X in this Case, would be an intermitting Reciprocating-Spring, whose Stream would reciprocate, but whose Reciprocations would sometimes stop, and have Fits of Intermission.

Such, in all probability, is the Fountain called *Laywell*, before described, whose Phenomena gave occasion to these Thoughts, and seem capable of being accounted for by such a Contrivance. And for the better Discovery of the Nature of this Fountain, whether it is owing to such a Piece of Natural Machinery, or otherwise, it would be proper to observe the length of Time of each Increase, Decrease, and Pause in every Reciprocation, together with the Number of Reciprocations in every Reciprocating-Fit, and likewise the length of the Intermissions of the said Fits. These Observations should be continued for some Time, both in a settled Season, when the Feeding-Stream at O cannot change, and in Variety of Seasons, when the said Stream may be altered.

Having now brought these Thoughts to the End proposed, *viz.* an Explanation of such a Fountain as *Laywell*, I shall carry them no farther; but conclude, by presenting to the View of the *Society*, an artificial Fountain of this kind, *Fig. 5* which being very easily made, may be buried in the Bottom or Slope of a Terrass, where a constant Stream of Water can be brought, and will furnish us with a new sort of Water-Works in Gardens. The two Reservoirs ABCD, EFGH, with their Syphons MNP, STV, and the

third Reservoir IKKL, with its Out-let X, are included in a Box YYY. Into this Box at λ enters a Funnel $\Gamma\Lambda\Gamma$ divided within the Box into two Pipes, viz. λO , which serves for a Feeding-Stream to the great Reservoir, and λW , which serves for a constant Stream to the third Reservoir. A Stream of Water being let into the Funnel $\Gamma\Lambda\Gamma$, will discharge itself like such an intermitting Reciprocating Fountain at X, where there is a Baton YZZZ without the Box to receive it; with an Out-let α , and a Diagonal Gage ZY, to mark the Rise and Fall of the Water in the Baton.

III. *Immerfiones, atque Emerfiones Satellitum Jovis Observatæ Pekini a P. P. Ignatio Kegler, & Andrea Pereira, Soc. JESU, a mense Novem. 1730, ad Rev^d. P. Johannem Baptistam Carbone, Soc. JESU, R. S. S. transmissæ; et ex ejusdem Cl. Viri Epistolâ ad Jacobum de Castro Sarmiento, M. D. Col. Medic. Lond. L. & R. S. S. excerptæ.*

SATELL. I.

1730	Immerfiones	Nov.	3 ^d	18 ^h	00'	p. m.	
			12	14	20		
			19	16	12		
			26	18	3		
			Dec.	5	14	22	54 ^h
				12	16	11	30
				19	18	00	45

Dec.

TAB. I.

Philos

Fig. 3.

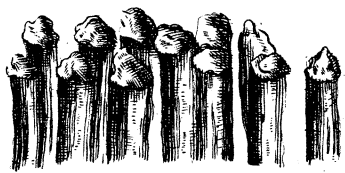

Fig. 1.

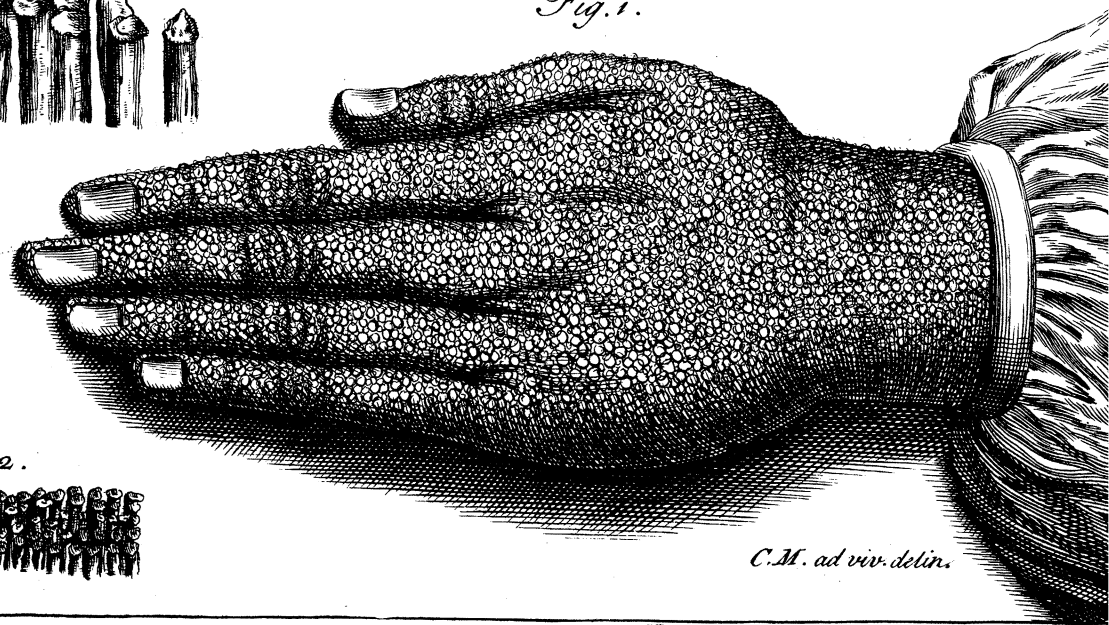

Fig. 2.



C.M. ad viv. delin.

TAB. II.

Fig. 1.

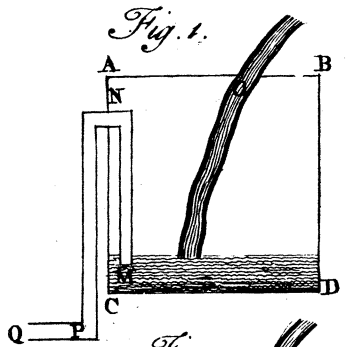

Fig. 2.

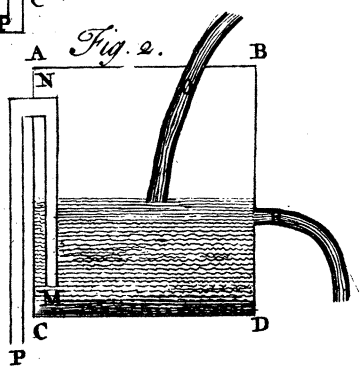

Fig. 3.

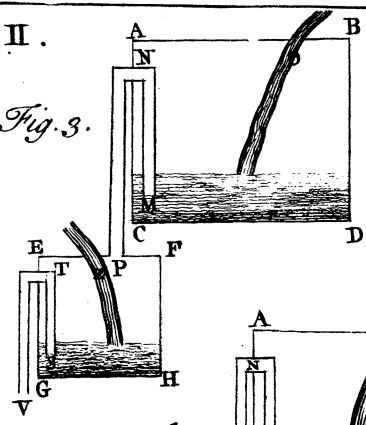

Fig. 4.

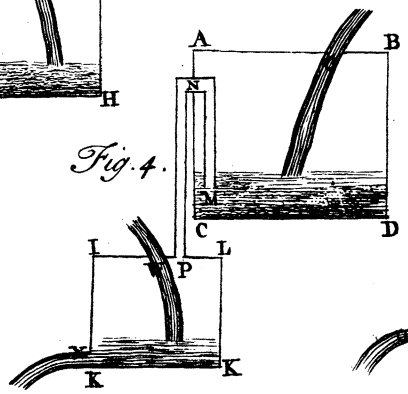
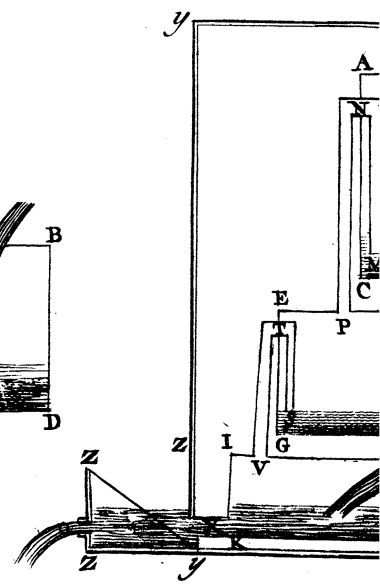
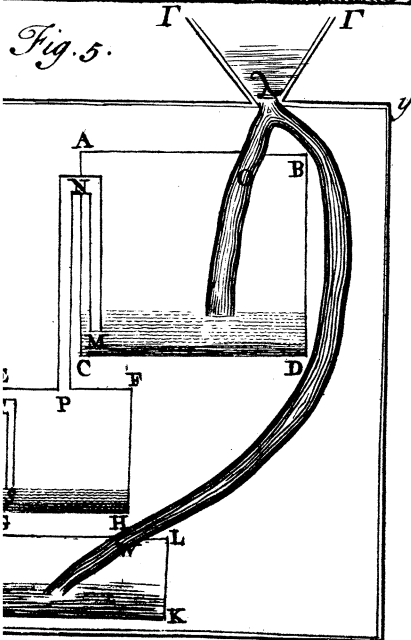
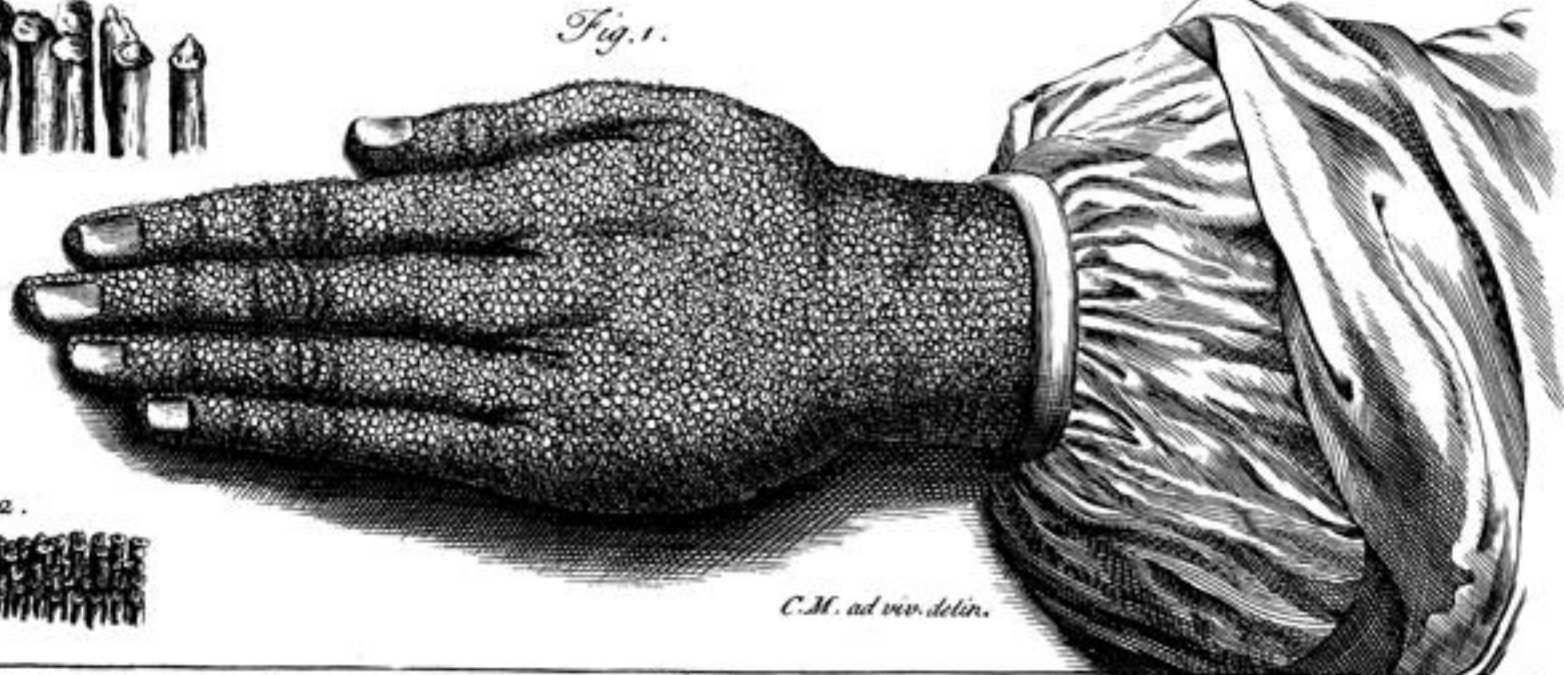

Fig. 5





J. Mynde sc.



C.M. ad viv. delin.



TAB. II.

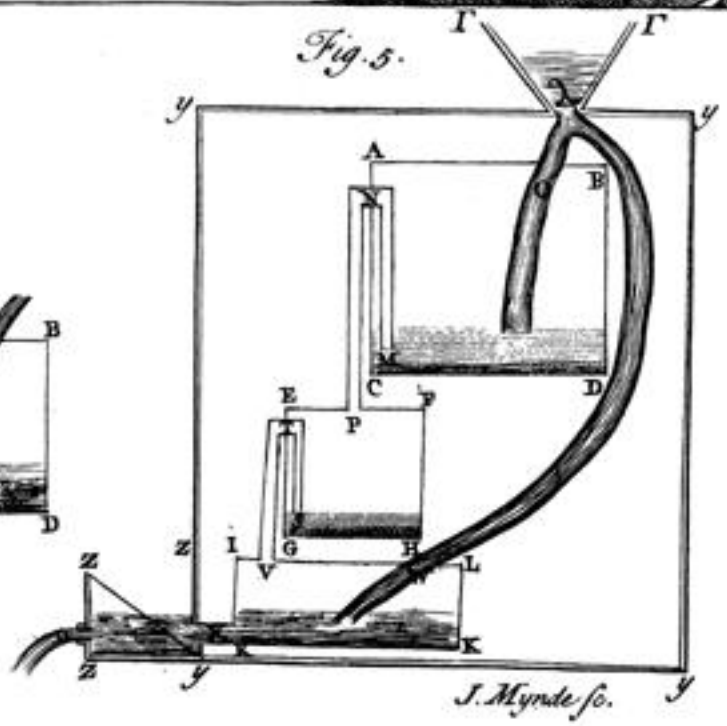
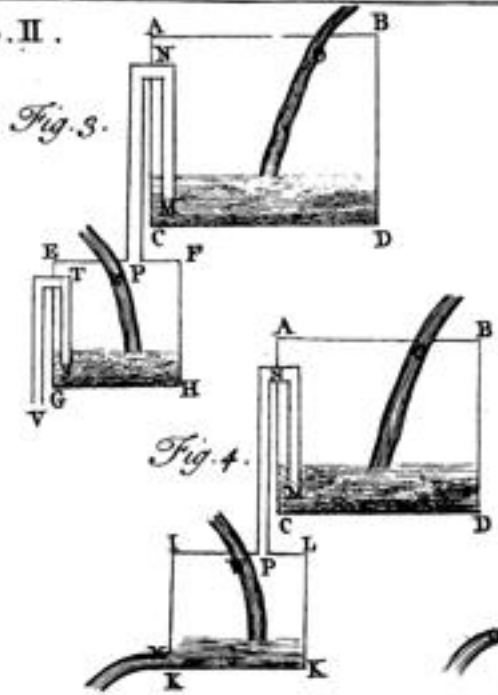
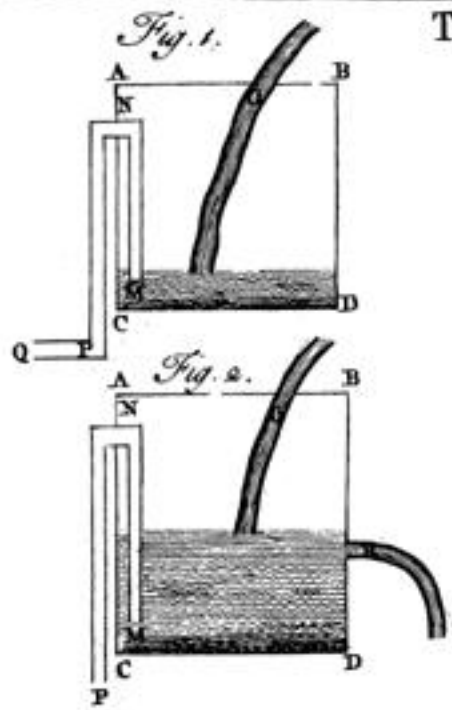

J. Mynde sc.